

BRD65R600C

Rev.D Jul.-2016

描述 / Descriptions

TO-252 塑封封装 N 沟道 650V 超结工艺功率场效应管。

N-CHANNEL 650V Super-Junction Power MOSFET in a TO-252 Plastic Package.

特征 / Features

低 $R_{DS(on)} \times Q_g$, 100%雪崩测试, 符合 ROHS 标准。

Very low $R_{DS(on)} \times Q_g$, 100%avalanche tested, RoHS compliant.

用途 / Applications

用于开关电源, 不间断电源, 功率因素校正。

For switch mode power supply, uninterruptible power supply, power factor correction.

内部等效电路 / Equivalent Circuit

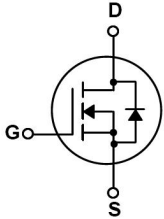

引脚排列 / Pinning

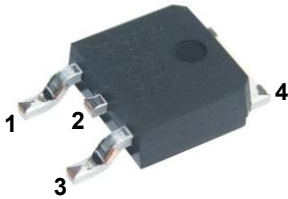

PIN1 : G

PIN 2,4 : D

PIN 3 : S

放大及印章代码 / h_{FE} Classifications & Marking

见印章说明。 See Marking Instructions.

极限参数 / Absolute Maximum Ratings(Ta=25°C)

参数 Parameter	符号 Symbol	数值 Rating	单位 Unit
Drain-Source Voltage	V_{DSS}	650	V
Drain Current	$I_D(T_c=25^\circ\text{C})$	7.0	A
Drain Current - Pulsed(note1)	I_{DM}	21	A
Gate-Source Voltage	V_{GSS}	±30	V
Single Pulsed Avalanche Energy(note2)	E_{AS}	140	mJ
Repetitive Avalanche Energy(note1)	E_{AR}	0.2	mJ
Avalanche Current(note1)	I_{AR}	3.0	A
Power Dissipation	$P_D(T_c=25^\circ\text{C})$	62.5	W
Operating and Storage Temperature Range	T_J, T_{STG}	-55 to 150	°C
Junction-to-Case	$R_{\theta JC}$	2.0	°C/W
Junction-to-Ambient	$R_{\theta JA}$	62	°C/W

电性能参数 / Electrical Characteristics(Ta=25°C)

参数 Parameter	符号 Symbol	测试条件 Test Conditions	最小值 Min	典型值 Typ	最大值 Max	单位 Unit
Drain-Source Breakdown Voltage	BV_{DSS}	$V_{GS}=0V$ $I_D=250\mu A$	650			V
Zero Gate Voltage Drain Current	I_{DSS}	$V_{DS}=650V$ $V_{GS}=0V$ $T_J=25^\circ\text{C}$			1.0	μA
		$V_{DS}=650V$ $T_J=150^\circ\text{C}$			100	μA
Gate-Body Leakage Current, Forward	I_{GSS}	$V_{GS}=\pm 30V$			±100	nA
Gate Threshold Voltage	$V_{GS(th)}$	$V_{DS}=V_{GS}$ $I_D=250\mu A$	2.5		4.0	V
Static Drain-Source On-Resistance(note3)	$R_{DS(on)}$	$V_{GS}=10V$ $I_D=3.0A$		0.6	0.62	Ω
Forward Transconductance(note3)	g_{FS}	$V_{DS}=10V$ $I_D=3.0A$		2.5		S
Drain-Source Diode Forward Voltage	V_{SD}	$V_{GS}=0V$ $I_{SD}=7.0A$ $T_J=25^\circ\text{C}$		0.9	1.2	V
Input Capacitance	C_{iss}	$V_{DS}=50V$ $V_{GS}=0V$ $f=1.0\text{MHz}$		450		pF
Output Capacitance	C_{oss}			82		pF
Reverse Transfer Capacitance	C_{rss}			4.0		pF
Turn-On Delay Time	$t_{d(on)}$		$V_{DD}=300V$ $I_D=7.0A$ $R_G=25\Omega$		14	31
Turn-On Rise Time	t_r			32	66	ns
Turn-Off Delay Time	$t_{d(off)}$			53	109	ns
Turn-Off Fall Time	t_f			15	32	ns

电性能参数 / Electrical Characteristics(Ta=25°C)

参数 Parameter	符号 Symbol	测试条件 Test Conditions	最小值 Min	典型值 Typ	最大值 Max	单位 Unit
Continuous Body Diode Current	I_S	$T_C=25^\circ\text{C}$			7.0	A
Pulsed Diode Forward Current	I_{SM}				21	A
Total Gate Charge	Q_g	$V_{DD}=480\text{V}$ $I_D=7.0\text{A}$ $V_{GS}=10\text{V}$		10		nC
Gate-Source Charge	Q_{gs}			2.5		nC
Gate-Drain Charge	Q_{gd}			4.5		nC
Reverse Recovery Time	t_{rr}	$V_R=480\text{V}$ $I_F=I_S$ $di_F/dt=100\text{A}/\mu\text{s}$		400		ns
Reverse Recovery Charge	Q_{rr}			1.5		μC
Peak Reverse Recovery Current	I_{rrm}			7.0		A

Notes

- 1.Repetitive Rating: Pulse width limited by maximum junction temperature
2. $I_{AS}=3.0\text{A}$, $V_{DD}=50\text{V}$, $R_G=25\Omega$, Starting $T_J=25^\circ\text{C}$
- 3.Pulse Test: Pulse width $\leq 300\mu\text{s}$, Duty Cycle $\leq 1\%$

电参数曲线图 / Electrical Characteristic Curve

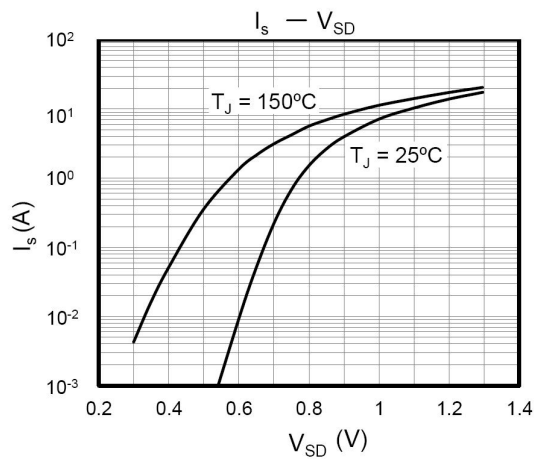
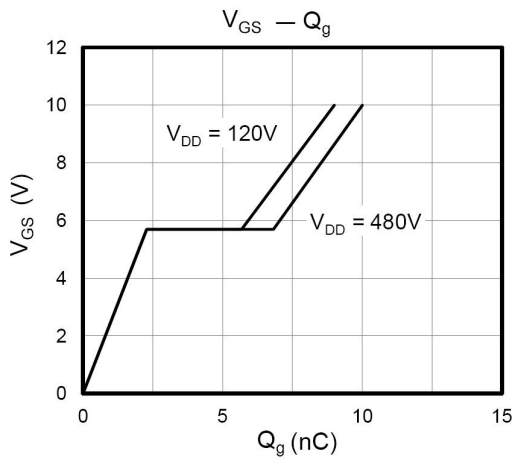
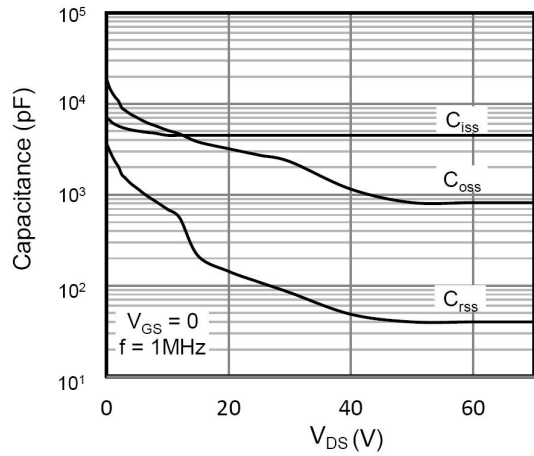
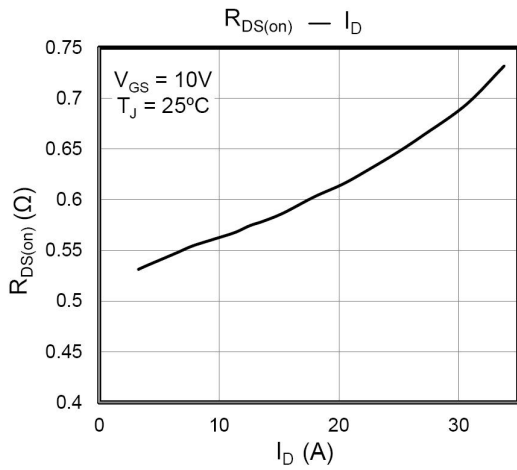
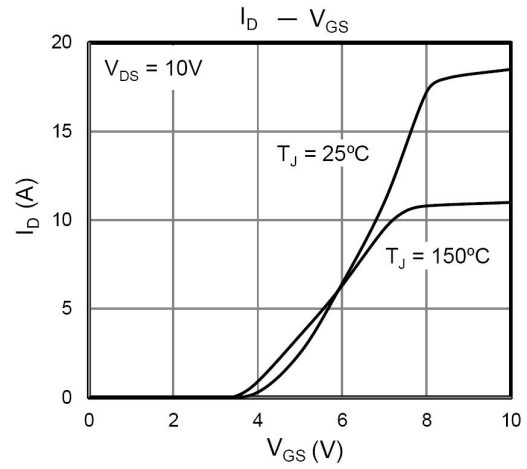
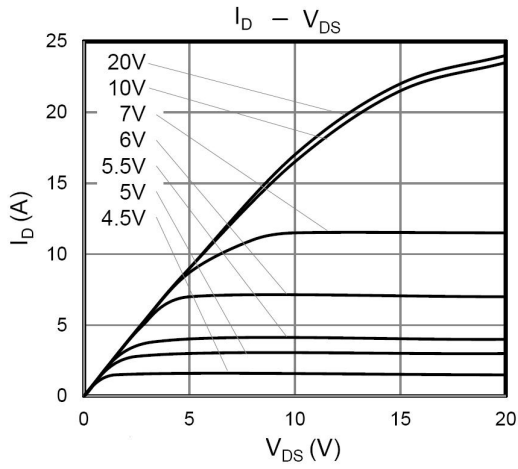

电参数曲线图 / Electrical Characteristic Curve

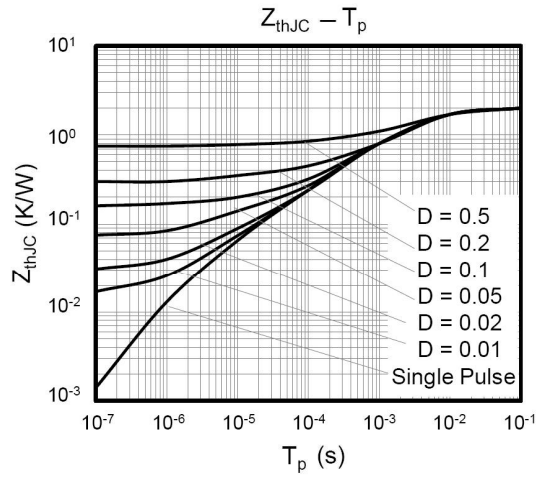
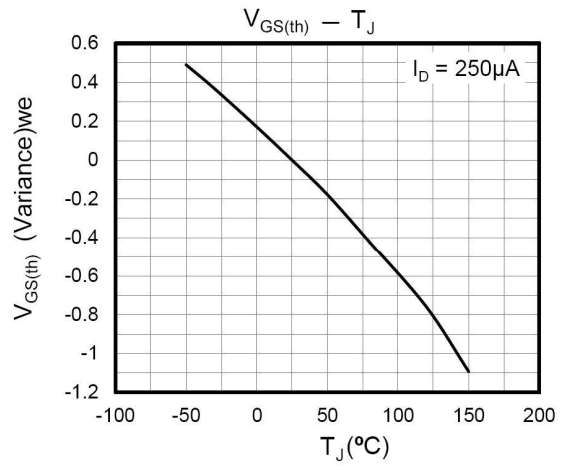
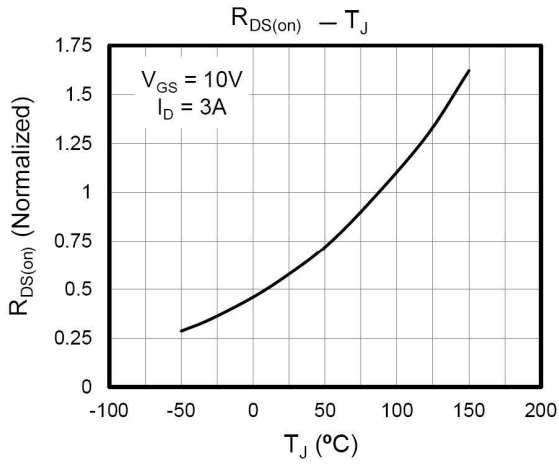

测试电路与波形图 / Test Circuit and Waveform Curve

Gate Charge Test Circuit and Waveform

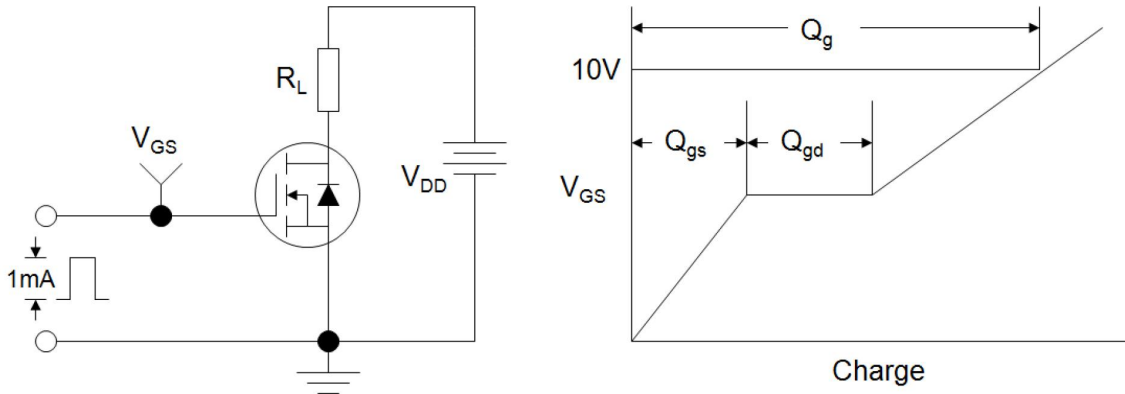

Resistive Switching Test Circuit and Waveform

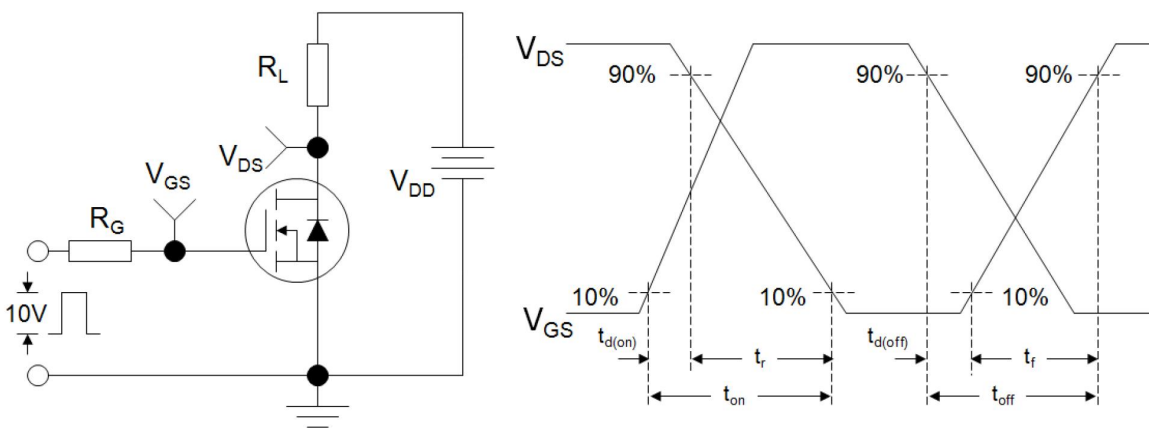

Unclamped Inductive Switching Test Circuit and Waveform

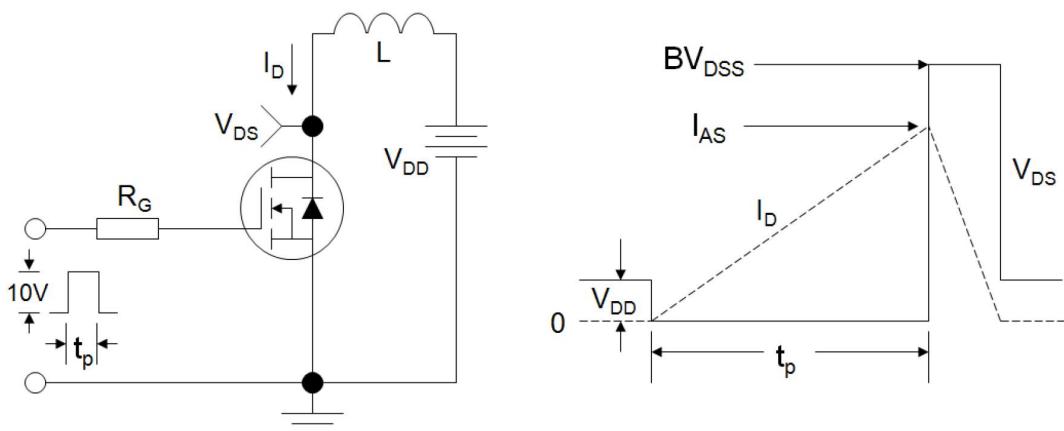

外形尺寸图 / Package Dimensions

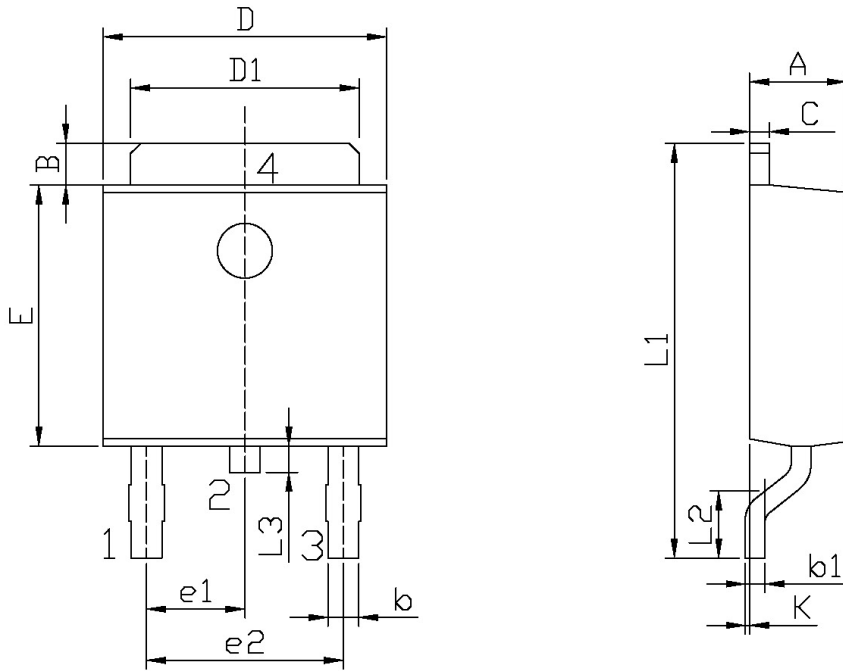

单位: mm

Symbol	Dimensions In Millimeters		Symbol	Dimensions In Millimeters	
	Min	Max		Min	Max
A	2.20	2.40	E	5.95	6.25
B	0.95	1.25	e1	2.24	2.34
b	0.50	0.70	e2	4.43	4.73
b1	0.45	0.55	L1	9.45	9.95
C	0.45	0.55	L2	1.25	1.75
D	6.45	6.75	L3	0.60	0.90
D1	5.10	5.50	K	0.00	0.10

TO-252

印章说明 / Marking Instructions

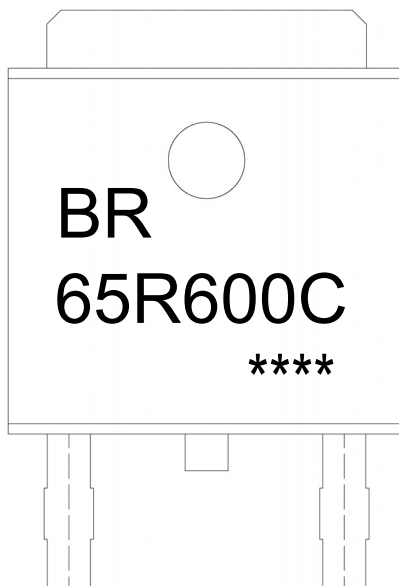

说明：

BR： 为公司代码

65R600C： 为型号代码

****： 为生产批号代码，随生产批号变化。

Note:

BR: Company Code

65R600C: Product Type.

****: Lot No. Code, code change with Lot No.

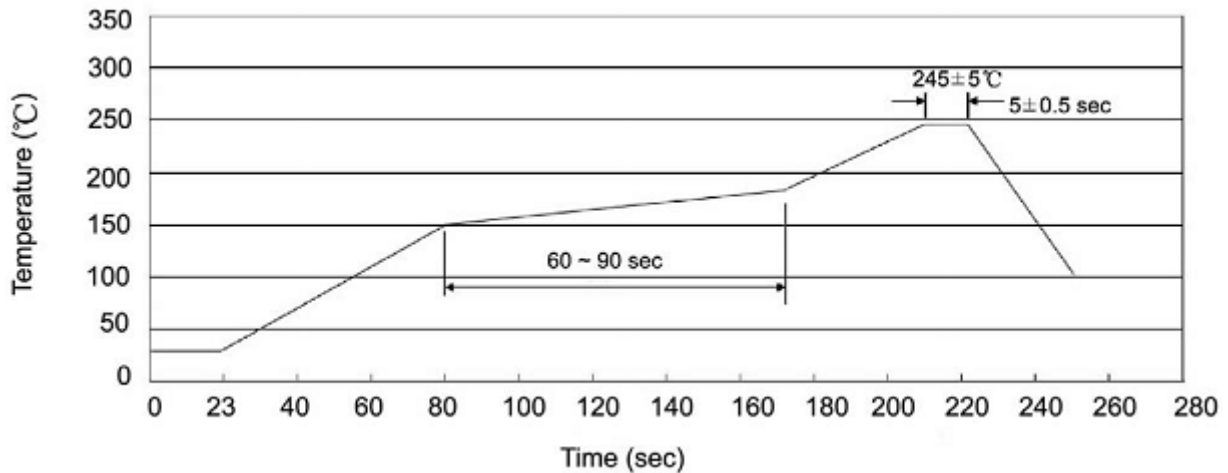
波峰焊温度曲线图(无铅) / Temperature Profile for Dip Soldering(Pb-Free)

说明：

- 1、预热温度 25~150°C，时间 60~90sec；
- 2、峰值温度 245±5°C，时间持续为 5±0.5sec；
- 3、焊接制程冷却速度为 2~10°C/sec.

Note:

- 1.Preheating:25~150°C, Time:60~90sec.
- 2.Peak Temp.:245±5°C, Duration:5±0.5sec.
3. Cooling Speed: 2~10°C/sec.

耐焊接热试验条件 / Resistance to Soldering Heat Test Conditions

温度：260±5°C

时间：10±1 sec.

Temp.:260±5°C

Time:10±1 sec

包装规格 / Packaging SPEC.

卷盘包装 / REEL

Package Type 封装形式	Units 包装数量					Dimension 包装尺寸 (unit: mm ³)		
	Units/Reel 只/卷盘	Reels/Inner Box 卷盘/盒	Units/Inner Box 只/盒	Inner Boxes/Outer Box 盒/箱	Units/Outer Box 只/箱	Reel	Inner Box 盒	Outer Box 箱
TO-252	2,500	2	5,000	5	25,000	13" × 16	360×360×50	385×257×392

套管包装 / TUBE

Package Type 封装形式	Units 包装数量					Dimension 包装尺寸 (unit: mm ³)		
	Units/Tube 只/套管	Tubes/Inner Box 套管/盒	Units/Inner Box 只/盒	Inner Boxes/Outer Box 盒/箱	Units/Outer Box 只/箱	Tube 套管	Inner Box 盒	Outer Box 箱
TO-251/252	75	48	3,600	5	18,000	526×20.5×5.25	555×164×50	575×290×180

使用说明 / Notices